REMER



WINNER
COLLECTION

WINNER

ESTETICA E FUNZIONALITA'

AESTHETICS AND FUNCTIONALITY



Una linea semplice, progettata nei minimi dettagli per essere leggera ed estremamente funzionale in tutte le sue figure di bagno e cucina. Le sue forme essenziali si inseriscono con facilità in contesti moderni, mentre i suoi contorni discreti aggiungono un tocco di eleganza alle ambientazioni più classiche. La serie è dotata di cartuccia a dischi ceramici Ø 35 mm.

A simple line, designed up to the minimum detail to be lightweight and extremely functional in all its models for bathroom and kitchen. Its essential shapes easily fit in modern contexts, while its soft edges add a touch of elegance to the most traditional environments. The series is equipped with a Ø 35 mm ceramic disc cartridge.





W11



W53D2PWB



W15NO



W11BO

//////////////////// OPZIONI DI FINITURA - FINISHING OPTIONS //////////////////////

| CR | | FIN 1 | | FIN 2 | |
|---|-----------------|---|-----------------------------|-------|--|
|  | cromo chrome |  | nero opaco matt black | | |
| | CR |  | bianco opaco matt white | NO | |
| | |  | visual inox visual steel | BO | |
| | | | | XV | |

MISCELATORI LAVABO - WASHBASIN MIXERS



W10
Miscelatore monocomando lavabo, con scarico.
Single-lever basin mixer, with pop-up waste.

CR FIN 1



W10P
Miscelatore monocomando lavabo, con scarico in plastica.
Single-lever basin mixer, with plastic waste.

CR



W11
Miscelatore monocomando lavabo, senza scarico.
Single-lever basin mixer, without waste.

CR FIN 1



W10S
Miscelatore monocomando lavabo, con scarico.
Single-lever basin mixer, with pop-up waste.

CR FIN 1



W10L
Miscelatore monocomando lavabo alto L, con scarico click-clack con troppo-pieno.
Single-lever high L basin mixer, with click-clack waste and overflow.

CR FIN 1

W11S
Miscelatore monocomando lavabo, senza scarico.
Single-lever basin mixer, without waste.

CR FIN 1



W57
Miscelatore monocomando lavabo due fori, senza scarico.
Two holes single-lever washbasin mixer, without waste.

CR FIN 1

W12S
Miscelatore monocomando lavabo, senza scarico e senza foro sul corpo.
Single-lever basin mixer, without waste and without body hole.

CR FIN 1

W11L
Miscelatore monocomando lavabo alto L, senza scarico.
Single-lever high L basin mixer, without waste.

CR FIN 1



W15
Miscelatore monocomando a incasso per lavabo, con piastra orizzontale in ottone.
Single-lever built-in basin mixer, with wall plate in brass.

CR FIN 1

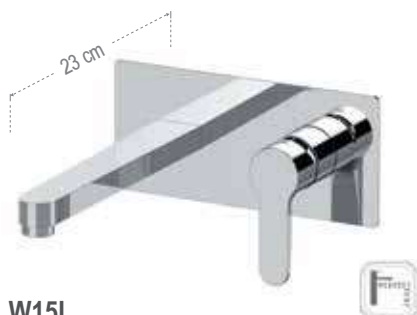

W15L
Miscelatore monocomando a incasso per lavabo, con piastra orizzontale in ottone, lunghezza bocca 23 cm.
Single-lever built-in basin mixer, with wall plate in brass, spout length cm 23.

CR FIN 1



W72C
Miscelatore monocomando lavabo senza scarico, con canna corta girevole a "U", tipo lusso.
Single-lever basin mixer without waste, with short swivel "U" spout, luxury type.

CR FIN 1

BOCCHIE - SPOUTS



W72

Miscelatore monocomando monoforo 90°, con canna alta girevole a "U".
Single-lever sink mixer 90°, high swivel "U" spout.

CR FIN 1

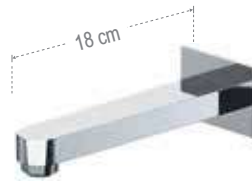

91L

Bocca incasso per miscelatore vasca/doccia.
Built-in spout for bath/shower mixer.

CR FIN 1

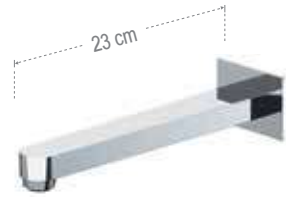

91LL

Bocca incasso per miscelatore vasca/doccia, lunghezza bocca 23 cm.
Built-in spout for bath/shower mixer, spout length cm 23.

CR FIN 1



91LD

Bocca incasso con deviatore integrato.
Built-in spout with diverter.

CR FIN 1

LAVABO A MURO CON BOX INCASSO - WALL WASHBASIN MIXER WITH BUILT-IN BOX

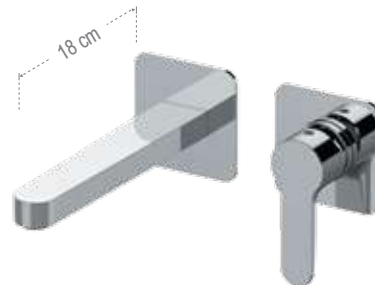
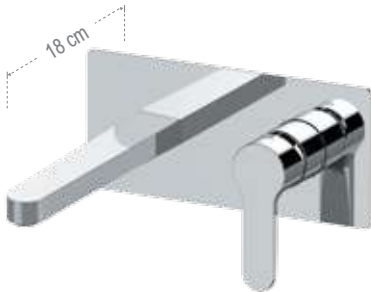

SOLO PARTE ESTERNA - EXPOSED COMPONENTS ONLY:

W15WB

Parti esterne per miscelatore monocomando a incasso per lavabo da abbinare al box incasso (non incluso). Piastra ultra-piatta. Lunghezza bocca 18 cm.
Exposed components for single-lever built-in basin mixer, with ultra-flat wall plate. To match with the built-in box (not included). Spout length 18 cm.

CR FIN 1

W15LWB

Idem sopra, con lunghezza bocca 23 cm.
Same as above, with spout length 23 cm.

CR FIN 1

SOLO PARTE ESTERNA - EXPOSED COMPONENTS ONLY:

W15PWB

Parti esterne per miscelatore monocomando a incasso per lavabo da abbinare al box incasso (non incluso). Su due piastre quadrate separate. Lunghezza bocca 18 cm.
Exposed components for single-lever built-in basin mixer, with two separate square plates. To match with the built-in box (not included). Spout length 18 cm.

CR FIN 1

W15PLWB

Idem sopra, con lunghezza bocca 23 cm.
Same as above, with spout length 23 cm.

CR FIN 1

SOLO PARTE INTERNA - BUILT-IN COMPONENTS ONLY:

WBOX15

SOLO PARTE INTERNA - BUILT-IN COMPONENTS ONLY:

WBOX15

MISCELATORI BIDET - BIDET MIXERS



W20

Miscelatore monocomando bidet, con scarico.
Single-lever bidet mixer, with pop-up waste.

CR

FIN 1



W20P

Miscelatore monocomando bidet, con scarico in plastica.
Single-lever bidet mixer, with plastic waste.

CR



W02

Miscelatore vasca con deviatore integrato, con flessibile cm 150 e doccetta a 4 funzioni con getti in silicone anticalcare e supporto snodato.
Wall mounted bath mixer with integrated diverter, with flexible cm 150 and 4 functions antilimestone handshower with silicon jets and swivel shower holder.

CR

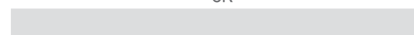

W22

Miscelatore monocomando per bidet, senza scarico e senza foro posteriore sul corpo.
Single-lever bidet mixer, without waste and without rear body hole.

CR

FIN 1



W65W

Miscelatore incasso per shut-off con supporto doccia/presa acqua integrato, attacco conico da 1/2", tutto in ottone, con doccetta shut-off e flessibile cm 120.

Built-in shower mixer with integrated shower holder/water punch on flange all in brass, with 1/2 connection, including shut-off and flexible hose cm 120.

CR

FIN 1



WC31DP

Miscelatore monocomando esterno doccia, interasse 100 mm, con doccetta shut-off e flessibile cm 120.

Wall mounted single lever shower mixer, interaxis 100 mm, including shut-off and flexible hose cm 120.

CR

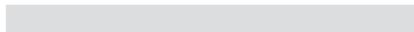

W05

Miscelatore vasca con deviatore integrato, senza kit doccia.
Wall mounted bath mixer with integrated diverter, without shower kit.

CR

FIN 1



W65B

Miscelatore incasso per shut-off con supporto doccia/presa acqua integrato, attacco conico da 1/2", tutto in ottone, senza kit doccia.

Built-in shower mixer with integrated shower holder/water punch on flange all in brass, with 1/2 connection, without shower kit.

CR

FIN 1



WC31

Miscelatore monocomando esterno doccia, interasse 100 mm, senza kit doccia.

Wall mounted single lever shower mixer, interaxis 100 mm, without shower kit.

CR

FIN 1



MISCELATORI ESTERNI PER VASCA E DOCCIA - EXPOSED MIXERS FOR BATH AND SHOWER



W03

Miscelatore monocomando per vasca, con flessibile cm 150 e doccetta a 4 funzioni, getti in silicone anticalcare e supporto snodato.

Single lever bath mixer with diverter, with flexible cm 150 and 4 functions antilimestone handshower with silicon jets and swivel shower holder.

CR



W49

Miscelatore lavabo/vasca con canna fusa lunghezza 30 cm con deviatore integrato, con flessibile cm 150 e doccetta a 4 funzioni con getti in silicone anticalcare e supporto snodato.

Wall mounted basin/bath single lever mixer with long casted spout length 30 cm and integrated diverter, with flexible cm 150 and 4 functions antilimestone handshower with silicon jets and swivel shower holder.

CR



W39

Miscelatore doccia, con flessibile cm 150 e doccetta a 4 funzioni con getti in silicone anticalcare e supporto snodato.

Exposed shower mixer, with flexible cm 150 and 4 functions antilimestone handshower with silicon jets and swivel shower holder.

CR



W04

Miscelatore monocomando per vasca, senza kit doccia.

Single lever bath mixer with diverter, without shower kit.

CR

FIN 1

W46

Miscelatore lavabo/vasca con canna fusa lunghezza 30 cm con deviatore integrato, senza kit doccia.

Wall mounted basin/bath single lever mixer with long casted spout length 30 cm and integrated diverter, without shower kit.

CR

FIN 1

W31

Miscelatore doccia, senza kit doccia.

Exposed shower mixer, without shower kit.

CR

FIN 1



W38

Miscelatore doccia con leva frontale, con flessibile cm 150 e doccetta a 4 funzioni con getti in silicone anticalcare e supporto snodato

Exposed shower mixer with frontal lever, with flexible cm 150 and 4 functions antilimestone handshower with silicon jets and swivel shower holder.

CR



W07UF

Miscelatore monocomando bordo vasca con deviatore integrato nel miscelatore, bocca a cascata e doccetta estribile in ABS cromato a 4 funzioni, flessibile 150 cm.

Single lever deck bath mixer with diverter integrated on the mixer, with waterfall spout and pull-out 4 functions chrome plated ABS handshower, flexible hose 150 cm.

CR



W07

Miscelatore monocomando bordo vasca con deviatore a leva integrato nella bocca minimale e doccetta estribile in ABS cromato a 4 funzioni, flessibile 150 cm.

Single lever deck bath mixer with lever diverter integrated on the spout, with minimal spout and pull-out 4 functions chrome plated ABS handshower, flexible hose 150 cm.

CR



W33

Miscelatore doccia con leva frontale, senza kit doccia.

Exposed shower mixer with frontal lever., without shower kit.

CR

FIN 1

MISCELATORI A INCASSO PER VASCA - BUILT-IN MIXERS FOR BATH



2 VIE
WAYS



SOLO PARTE ESTERNA - EXPOSED COMPONENTS ONLY:

W53D2WB

Set a incasso a 2 vie per vasca su piastra unica rettangolare.
2-way built-in set for bathtub on a single rectangular plate

CR

FIN 1



SOLO PARTE ESTERNA - EXPOSED COMPONENTS ONLY:

W53D2PWB

Set a incasso a 2 vie per vasca su piastre tonde separate.
2-way built-in set for bathtub on separate round plates.

CR

FIN 1

SOLO PARTE INTERNA - BUILT-IN COMPONENTS ONLY:

WBOX97D2

pag 304

SOLO PARTE INTERNA - BUILT-IN COMPONENTS ONLY:

WBOX97D2

pag 304



2 VIE
WAYS



SOLO PARTE ESTERNA - EXPOSED COMPONENTS ONLY:

W54D2WB

Set miscelatore a incasso a 2 vie per vasca/doccia su piastra unica rettangolare. Da completare con la seconda uscita.
2-way built-in mixer set for bathtub / shower on single rectangular plate. To be completed with the second water outlet.

CR

FIN 1



SOLO PARTE ESTERNA - EXPOSED COMPONENTS ONLY:

W54D2PWB

Set miscelatore a incasso a 2 vie per vasca/doccia su 3 piastre tonde. Da completare con la seconda uscita acqua.
2-way built-in mixer set for bathtub / shower on 3 round plates. To be completed with the second water outlet.

CR

FIN 1

SOLO PARTE INTERNA - BUILT-IN COMPONENTS ONLY:

WBOX97D2

pag 304

SOLO PARTE INTERNA - BUILT-IN COMPONENTS ONLY:

WBOX97D2

pag 304



3 VIE
WAYS



SOLO PARTE ESTERNA - EXPOSED COMPONENTS ONLY:

W54D3WB

Set miscelatore a incasso a 3 vie per vasca/doccia su piastra unica rettangolare. Da completare con la seconda e la terza uscita acqua.
3-way built-in mixer set for bathtub / shower on single rectangular plate. To be completed with the second and the third water outlet.

CR

FIN 1



SOLO PARTE ESTERNA - EXPOSED COMPONENTS ONLY:

W54D3PWB

Set miscelatore a incasso a 3 vie per vasca/doccia su 3 piastre tonde. Da completare con la seconda e la terza uscita acqua.
3-way built-in mixer set for bathtub / shower on 3 separate round plates. To be completed with the second and the third water outlet.

CR

FIN 1

SOLO PARTE INTERNA - BUILT-IN COMPONENTS ONLY:

WBOX97D3

pag 308

SOLO PARTE INTERNA - BUILT-IN COMPONENTS ONLY:

WBOX97D3

pag 308

MISCELATORI A INCASSO PER DOCCIA - BUILT-IN MIXERS FOR SHOWER

1 VIA WAY



W30
Miscelatore monocomando a incasso per doccia completo.
Complete built-in shower single lever mixer.

CR

FIN 1

2 VIE WAYS



W09
Miscelatore monocomando a incasso con deviatore per vasca/doccia completo.
Complete built-in bath/shower single-lever mixer with diverter.

CR

FIN 1

2 VIE WAYS

N09B
Solo parte interna.
Built-in components only.



CR

FIN 1

W09E
Solo parte esterna.
Exposed components only.

CR

FIN 1

2 VIE WAYS



W09H
Miscelatore a incasso per vasca/doccia con deviatore a 2 vie a vitone ceramico, su piastra tonda. Per selezionare l'uscita desiderata, la manopola del deviatore deve essere ruotata da una posizione all'altra.
Built-in bath/shower mixer with 2-way diverter with ceramic head valve, on round wall plate. To select the desired output, the diverter knob must be turned from one position to the other.

CR

FIN 1

2 VIE WAYS



W09HRG
Miscelatore a incasso per vasca/doccia con deviatore a 2 vie con vitone ceramico, su piastra rettangolare, montaggio orizzontale. Per selezionare l'uscita desiderata, la manopola del deviatore deve essere ruotata da una posizione all'altra.
Built-in bath/shower mixer with 2-way diverter with ceramic head valve, on rectangular plate, horizontal mounting. To select the desired output, the diverter knob must be turned from one position to the other.

CR

FIN 1

2 VIE WAYS

N09HB
Solo parte interna.
Built-in components only.



CR

FIN 1

W09E
Solo parte esterna.
Exposed components only.

CR

FIN 1

N09HRB
Solo parte interna.
Built-in components only.



CR

FIN 1

W09GE
Solo parte esterna.
Exposed components only.

CR

FIN 1

2 VIE
WAYS

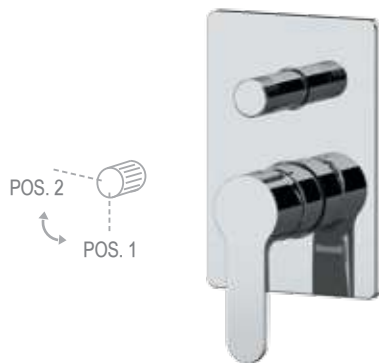

W09HG

Miscelatore a incasso per vasca/doccia con deviatore a 2 vie a vitone ceramico, su piastra rettangolare. Per selezionare l'uscita desiderata, la manopola del deviatore deve essere ruotata da una posizione all'altra.
Built-in bath/shower mixer with 2-way diverter with ceramic head valve, on rectangular wall plate. To select the desired output, the diverter knob must be turned from one position to the other.

CR

FIN 1



W92

Miscelatore monocomando a incasso per doccia, con deviatore a due posizioni (due uscite ed una entrata) su piastra unica.
Single-lever built-in shower mixer with 2 positions diverter (2 outlets and 1 inlet) on single plate.

CR

FIN 1



N09HB

Solo parte interna.
Built-in components only.



CR

FIN 1



W09GE

Solo parte esterna.
Exposed components only.

CR

FIN 1



2 VIE
WAYS



SOLO PARTE ESTERNA - EXPOSED COMPONENTS ONLY:

W92ZWB

Miscelatore a incasso per vasca/doccia con deviatore a 2 vie di tipo meccanico, su piastra rettangolare.
Built-in bath/shower mixer with 2-way mechanical diverter, on rectangular plate.

CR

FIN 1



SOLO PARTE ESTERNA - EXPOSED COMPONENTS ONLY:

W92ZPWB

Miscelatore a incasso per vasca/doccia con deviatore a 2 vie di tipo meccanico, su due piastre tonde.
Built-in bath/shower mixer with 2-way mechanical diverter, on two round plates.

CR

FIN 1



SOLO PARTE INTERNA - BUILT-IN COMPONENTS ONLY:

WBOX92Z

pag 300

SOLO PARTE INTERNA - BUILT-IN COMPONENTS ONLY:

WBOX92Z

pag 300

2 VIE
WAYS



SOLO PARTE ESTERNA - EXPOSED COMPONENTS ONLY:

W97D2PWB

Set miscelatore a incasso a 2 vie per vasca/doccia su 3 piastre tonde. Da completare con la seconda uscita.
2-way built-in shower mixer set on 3 round plates. To be completed with the second water outlet.

CR

FIN 1



SOLO PARTE ESTERNA - EXPOSED COMPONENTS ONLY:

W97D2WB

Set miscelatore a incasso a 2 vie per vasca/doccia su piastra rettangolare. Da completare con la seconda uscita.
2-way built-in shower mixer set on rectangular plate. To be completed with the second water outlet.

CR

FIN 1

SOLO PARTE INTERNA - BUILT-IN COMPONENTS ONLY:

WBOX97D2

> pag 304

SOLO PARTE INTERNA - BUILT-IN COMPONENTS ONLY:

WBOX97D2

> pag 304

3 VIE
WAYS



SOLO PARTE ESTERNA - EXPOSED COMPONENTS ONLY:

W93ZWB

Miscelatore a incasso per vasca/doccia con deviatore a 3 vie di tipo meccanico, su piastra rettangolare.
Built-in bath/shower mixer with 3-way mechanical diverter, on rectangular plate.

CR

FIN 1



SOLO PARTE ESTERNA - EXPOSED COMPONENTS ONLY:

W93ZPWB

Miscelatore a incasso per vasca/doccia con deviatore a 3 vie di tipo meccanico, su due piastre tonde.
Built-in bath/shower mixer with 3-way mechanical diverter, on two round plates.

CR

FIN 1

SOLO PARTE INTERNA - BUILT-IN COMPONENTS ONLY:

WBOX93Z

> pag 302

SOLO PARTE INTERNA - BUILT-IN COMPONENTS ONLY:

WBOX93Z

> pag 302

3 VIE
WAYS



SOLO PARTE ESTERNA - EXPOSED COMPONENTS ONLY:

W97D3PWB

Set miscelatore a incasso a 3 vie per vasca/doccia su 3 piastre tonde. Da completare con la seconda e la terza uscita acqua.

3-way built-in bath/shower mixer set on 3 round plates. To be completed with the second and the third water outlet.

CR

FIN 1



SOLO PARTE ESTERNA - EXPOSED COMPONENTS ONLY:

W97D3WB

Set miscelatore a incasso a 3 vie per vasca/doccia su piastra rettangolare. Da completare con la seconda e la terza uscita acqua.

3-way built-in shower mixer set on rectangular plate. To be completed with the second and the third water outlet.

CR

FIN 1

SOLO PARTE INTERNA - BUILT-IN COMPONENTS ONLY:

WBOX97D3

pag 308

SOLO PARTE INTERNA - BUILT-IN COMPONENTS ONLY:

WBOX97D3

pag 308



W93

Miscelatore monocomando per doccia con deviatore a tre vie (una entrata e tre uscite) su unica piastra.

Single lever built-in shower mixer with three ways diverter (1 inlet and 3 outlets) on single plate.

CR

FIN 1

SALISCENDI E COLONNE DOCCIA - SLIDING RAILS AND SHOWER COLUMNS

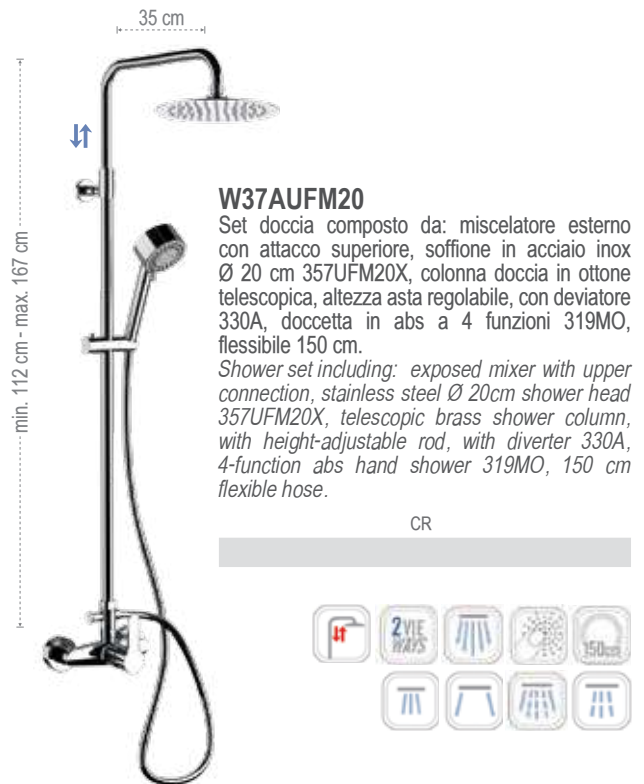

WINNER | SET

COMPOSIZIONE DEL BOX - BOX COMPOSITION:

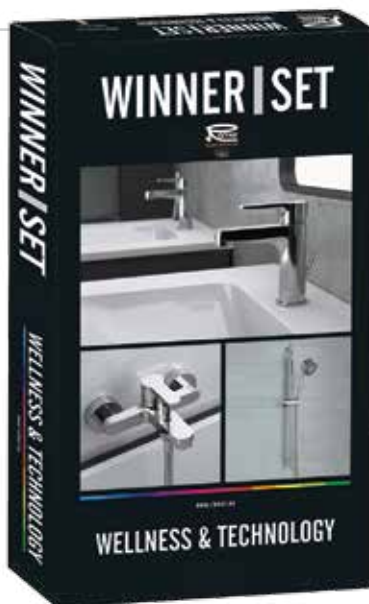

W0510315RMOI

Set composto da: miscelatore vasca esterno W05, saliscendi tondo 315R, miscelatore per lavabo con scarico W10, doccia in abs a 4 funzioni 319MO, flessibile 150 cm.

Set including: Exposed bath mixer W05, round sliding rail 315R, basin mixer with pop-up waste W10, 4-function abs hand shower 319MO, 150 cm flexible hose.

CR



COMPOSIZIONE DEL BOX - BOX COMPOSITION:

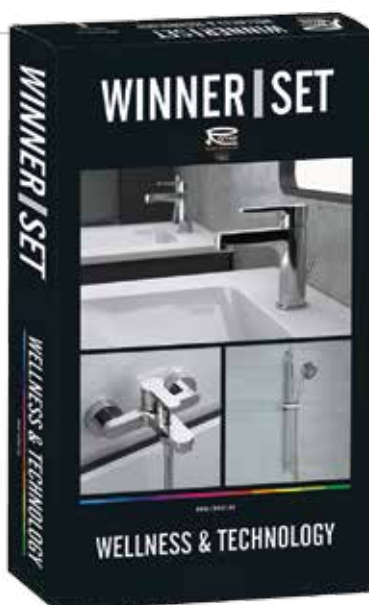

W0910315RMOI

Set composto da: miscelatore a incasso con deviatore, soffione in abs Ø 20cm 354EC20X, braccio in ottone 30 cm, saliscendi tondo 315R, miscelatore per lavabo con scarico W10, presa acqua a muro, doccia in abs a 4 funzioni 319MO, flessibile 150 cm.

Set including: built-in mixer with diverter, abs Ø 20 cm shower head 354EC20X, brass arm 30 cm, round sliding rail 315R, basin mixer with pop-up waste W10, wall water connection, 4-function abs hand shower 319MO, 150 cm flexible hose..

CR



COMPOSIZIONE DEL BOX - BOX COMPOSITION:

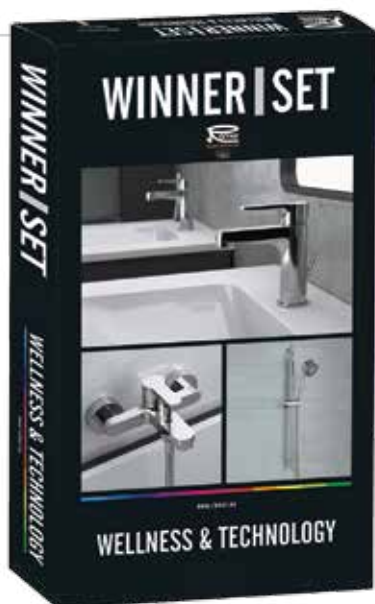

W051020315RMOI

Set composto da: miscelatore vasca esterno W05, saliscendi tondo 315R, miscelatore per lavabo con scarico W10, miscelatore bidet con scarico (W20), doccetta in abs a 4 funzioni 319MO, flessibile 150 cm.

Set including: Exposed bath mixer W05, round sliding rail 315R, basin mixer with pop-up waste W10, bidet mixer with pop-up waste (W20); 4-function abs hand shower 319MO, 150 cm flexible hose.

CR



WINNER_{ECO}



WINNER ECO è una collezione monocomando dal design moderno e giovanile, creata per controllare e ridurre i consumi idrici ed energetici in casa. La combinazione di più tecnologie di risparmio permette infatti di limitare alla sola necessità sia il consumo di acqua che l'utilizzo di acqua calda, senza stravolgere le abitudini quotidiane. La serie è dotata di cartuccia ENERGY SAVING a dischi ceramici Ø 35 mm.

WINNER ECO is a single-lever collection with a modern and youthful design, created to control and reduce water and energy consumption in the home. The combination of different saving technologies limit to the actual need both the consumption of water and the use of hot water, without upsetting daily habits. The series is equipped with a Ø 35 mm ceramic disc ENERGY SAVING cartridge.



WE12LT6



PROGRAMMA ECO ECO PROGRAM



Design e tecnologia ambientale Design and environmental technology

Il programma ECO nasce per il controllo dei consumi, per un reale risparmio sia economico che ambientale. WINNER ECO combina diverse tecnologie di risparmio: cartuccia ENERGY SAVING, aeratore WATER SAVING, anello ANTISCALDING, leva WATER SAVING DYNAMIC.

Funzioni standard incluse:

La cartuccia **ENERGY SAVING** di serie evita la richiesta accidentale e involontaria di acqua calda, consentendo un risparmio energetico.

Questa funzione prevede l'apertura in sola acqua fredda quando la leva è allineata alla bocca del miscelatore; per l'erogazione di acqua calda è invece necessario un movimento volontario della leva verso sinistra.

Aeratore **WATER SAVING** di serie. I miscelatori WINNER ECO sono dotati di serie di un aeratore con limitazione di portata di 6 litri al minuto (disponibile anche nelle varianti da 8, 4, 3 L / min).

Per ottimizzare il risparmio, la collezione WINNER ECO può essere integrata, su richiesta, anche con le seguenti tecnologie opzionali:

Tecnologia **ANTISCALDING** per limitare la temperatura massima dell'acqua erogabile. Questa tecnologia applica una speciale ghiera sulla cartuccia che permette, previa regolazione durante l'installazione, la limitazione della temperatura massima erogabile, impedendo la completa rotazione della maniglia verso l'acqua calda.

Tecnologia **WATER SAVING DYNAMIC**: un promemoria per utilizzare solo la quantità di acqua strettamente necessaria ad ogni operazione. Questo sistema permette di percepire una leggera limitazione all'apertura della leva intorno al 50% dell'erogazione massima d'acqua del miscelatore: un invito per l'utente a non aprire completamente il flusso dell'acqua quando non strettamente necessario. Superando questa leggera resistenza, l'erogazione del flusso al 100% della portata rimane sempre possibile e con la solita morbidezza della leva.

ECO program is created to control consumption for effective economic and environmental savings. WINNER ECO combines different saving technologies: ENERGY SAVING cartridge, WATER SAVING aerator, ANTISCALDING ring, WATER SAVING DYNAMIC lever.

Standard features included:

ENERGY SAVING cartridge as standard equipment avoids the accidental and unintentional request of hot water, thus allowing energy savings.

This function provides for opening in only cold water when the lever is aligned with the mixer spout; for the supply of hot water a voluntary movement of the lever to the left is instead necessary.

WATER SAVING aerator: WINNER ECO mixers are standard equipped with a low flow aerator with a limitation of 6 liters per minute (also available in 8, 4, 3 L / min variants).

To optimize savings, WINNER ECO collection can also be easily integrated, on demand, with the following optional technologies:

ANTISCALDING ring technology to limit the maximum temperature of the water supplied. This technology applies a special ring nut on the cartridge that allows, after adjustment during installation, the limitation of the maximum deliverable temperature, preventing the complete rotation of the lever towards hot water.

WATER SAVING DYNAMIC technology: a reminder to use only the amount of water strictly necessary for each operation.

During the opening phase this system provides a slight limitation of the lever around the 50% of the maximum water supply: an invitation for the user not to fully open the water flow when not strictly necessary. By overcoming this slight resistance, the delivery of the flow at 100% of the flow is always possible and with the usual softness of the lever.

STANDARD ECO



ENERGY SAVING :

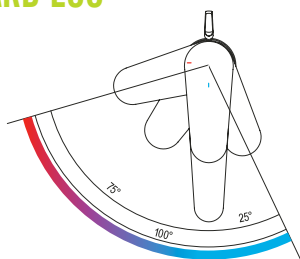

WATER SAVING :



OPTIONS:

3 L/MIN
4 L/MIN
8 L/MIN

COD. 83L6
STANDARD 6 L/min

OPTIONAL ECO



ANTISCALDING :



WATER SAVING
DYNAMIC :

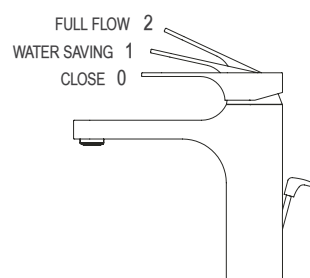



WE11LT6

La serie Eco viene proposta in una gamma di articoli in cui la tecnologia Eco trova migliori benefici nell'uso.

Gli articoli doccia e vasca non sono stati proposti in quanto si presuppone che non vi sia la necessità di apertura in acqua fredda in quanto gli ambienti vasca e doccia sono generalmente utilizzati per loro natura con acqua miscelata/calda. Per completare la gamma Eco con gli articoli vasca/doccia si consiglia di utilizzare la serie nella versione cartuccia standard.

Le versioni eco vasca e doccia sono comunque disponibili a richiesta.

The Eco series covers a range of items in which the Eco technology finds best benefit of use.

The shower and bathtub items are not offered because it is assumed that there is no need to open in cold water as the bathtub and shower environments are generally used with mixed/hot water for their nature.

To complete the Eco range with bath/shower items, we suggest to use the series in standard cartridge version.

The bath and shower eco versions are anyway available on demand.

WINNER ECO



FLESSIBILI MADE IN ITALY,
IN GOMMA ALIMENTARE EPDM,
RACCORDATI CON MACCHINE
AUTOMATICHE
MADE IN ITALY FLEXIBLE HOSES,
WITH EPDM ALIMENTARY RUBBER,
MADE BY AUTOMATIC
ASSEMBLING MACHINES



CARTUCCIA MADE IN ITALY
TECNOLOGICA REALIZZATA
CON PLASTICA ALIMENTARE
ECO FRIENDLY
MADE IN ITALY ECO FRIENDLY
TECHNOLOGIC CARTRIDGE

AERATORE A
RISPARMIO IDRICO
WATER SAVING
AERATOR

LAVABI ECO - ECO WASHBASIN MIXERS



WE10LT6

Miscelatore monocomando lavabo, con scarico.
Single-lever basin mixer, with pop-up waste.

CR

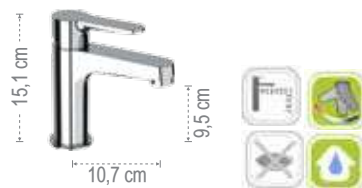

WE11LT6

Miscelatore monocomando lavabo, senza scarico.
Single-lever basin mixer, without waste.

CR



WE12LT6

Miscelatore monocomando lavabo, senza scarico e senza foro sul corpo.
Single-lever basin mixer, without waste and without body hole.

CR



WE10LLT6

Miscelatore monocomando lavabo alto L, con click-clack con troppo pieno.
Single-lever L high basin mixer, with click-clack waste with overflow.

CR



WE72CLT6

Miscelatore monocomando lavabo senza scarico, con canna corta girevole a "U", tipo lusso.
Single-lever basin mixer without waste, with short swivel "U" spout, luxury type.

CR



WE15LT6

Miscelatore monocomando a incasso per lavabo, con piastra rettangolare in ottone.
Single-lever built-in basin mixer, with rectangular wall plate in brass.

CR

WE11LLT6

Miscelatore monocomando lavabo alto L, senza scarico.
Single-lever L high basin mixer, without waste.

CR

BIDET ECO - ECO BIDET MIXERS



WE20LT6

Miscelatore monocomando bidet, con scarico.
Single-lever bidet mixer, with pop-up waste.

CR

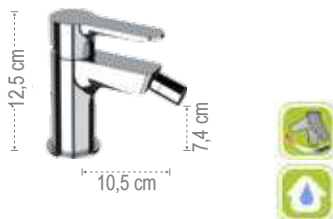

WE22LT6

Miscelatore monocomando per bidet, senza scarico e senza foro posteriore sul corpo.
Single-lever bidet mixer, without waste and without rear body hole.

CR



WE65LT6

Miscelatore incasso per shut-off comprensivo di: doccetta shut-off, supporto doccia-presa acqua su piastra in ottone e flessibile doccia cm 120.
Built-in shower mixer set including :shut-off, shower holder-water punch on flange, all in brass and shower flexible cm 120.

CR

SOFFIONI - SHOWER HEADS



351AXLT8

Soffione con disco anticalcare a snodo \varnothing 7 cm con limitatore di portata a 8 litri/minuto, con scatola.

Shower-head with anti-limestone jet \varnothing 7 cm with balljoint with 8 liters/minute flow limiter, box included.

CR



354EC20XLT8

Soffione a pioggia minimale, in abs cromato \varnothing 20 cm, con getti in silicone anticalcare con limitatore di portata a 8 litri/minuto, con scatola.

c.p. abs shower head, rain jet \varnothing 20 cm, with anti-limestone silicon jets with 8 liters/minute flow limiter, box included..

CR



357UFS25XLT8

Soffione doccia ultra piatto in acciaio inox lucidato a specchio 25x25cm, con limitatore di portata a 8 litri/minuto, con scatola.

Ultra slim stainless steel mirror polished shower head 25x25 cm, with 8 liters/minute flow limiter, box included.

CR



357UFM25XLT8

Soffione doccia ultra piatto in acciaio inox lucidato a specchio \varnothing 25 cm, con limitatore di portata a 8 litri/minuto, con scatola.

Ultra slim stainless steel mirror polished shower head \varnothing 25 cm, with 8 liters/minute flow limiter, box included.

CR

CUCINA ECO - ECO KITCHEN MIXERS



WE72LT6

Miscelatore monocomando monoforo 90°, con canna alta girevole a "U".

Single-lever sink mixer 90°, high swivel "U" spout.

CR



WE42LT6

Miscelatore monocomando per lavello, con bocca alta girevole.

Single-lever one-hole sink mixer, with high swivel spout.

CR



WE42CLT6

Miscelatore monocomando per lavello, canna corta girevole, tipo lusso.

Single-lever one-hole sink mixer, shorter swivel spout, luxury type.

CR



WE42RLT6

Miscelatore monocomando monoforo 90° per lavello, con bocca alta girevole ed abbattibile, tipo lusso, modello sottofinestra.

Single-lever one-hole sink mixer, with swivel and foldable high spout, luxury type, under window type.

CR



WE41LT6

Miscelatore monocomando per lavello a muro con canna girevole 20 cm.

Single-lever wall mounted sink mixer with swivel spout length 20 cm.

CR

LEGENDA ICONE - *ICONS LEGEND*



Acciaio INOX
Stainless Steel



Perfect Tune: Prodotto diponibile in più varianti.
Perfect Tune: Product available in different variants.

RUBINETTERIA - FAUCETS



Con scarico
With pop-up waste



Cartuccia Energy Saving
Energy Saving Cartridge



Con scarico in plastica
With plastic waste



Limitatore di Temperatura
Antiscalding



Con Click-Clack
With Click-Clak



Risparmio Idrico Dinamico
Water Saving Dynamic



Con Click-Clack con Troppo Pieno
With Click-Clak with Overflow



Risparmio Idrico
Water Saving



Senza Scarico
Without Waste



Risparmio Energetico
Energy Saving



Eco
Eco



Risparmio Idrico e Energetico
Water and Energy Saving

CUCINA - KITCHEN



Bocca Girevole
Swivel Spout



Bocca Abbattibile
Folding Spout



Corpo girevole
Swivel body



Doccetta a due funzioni
Two functions hand shower.



Doccetta Orientabile
Adjustable handshower



Acqua Frizzante
Sparkling Water



Doccetta Estraibile
Pull-Out Handshower



Acqua Potabile
Drinking Water

TECNOLOGIA - TECHNOLOGY



Touch-Me
Touch-Me



Azionamento a Sensore
Sensor Control



Tempor Touch
Tempor Touch



Con Temporizzazione per Lavatrice/Lavastoviglie
With Timing for washing/machine and Dish/Washer



Con Luce Led
Whit Led Light



Con filtro incluso
With filter included



Con Batterie Alcaline Include
With Alkaline Batteries included



Con Batterie al Litio Include
With Lithium Batteries included



Alimentazione Elettrica
Power Supply



Termostatico
Thermostatic

SOFFIONI - SHOWER HEADS



Getto effetto pioggia ad ampia copertura
Wide coverage rain effect



Getto effetto pioggia a risparmio idrico
Water-saving rain effect jet



Con Multigetto
With Multi Jet



Con Getto a Cascata
With Waterfall Jet



Getto Nebulizzato
Nebulized Jet



Cromoterapia
Colortherapy



Autopulente
Self-Cleaning



Con Getti Anticalcare
With Antilime Jets

KIT DOCCIA - SHOWER KIT



2 Vie
2 Ways



3 Vie
3 Ways



4 Vie
4 Ways



5 Vie
5 Ways



Flessibile Lungo 120 cm
Flexible Length 120 cm



Flessibile Lungo 150 cm
Flexible Length 150 cm



Flessibile Lungo 200 cm
Flexible Length 200 cm

DOCCHETTE - HANDSHOWERS



Posizione d'interruzione getto
Stop flow position



Getto intenso esterno con getto effetto pioggia interno
Intense external jet with internal rain effect jet



Getto intenso a risparmio idrico
Intense water-saving jet



Massaggio vigoroso ampia copertura effetto pioggia
Vigorous massage wide coverage rain jet



Getto vigoroso concentrato e getto esterno
Concentrated vigorous jet and external jet



Getto vigoroso concentrato
Vigorous concentrated jet



Getto Aerato Intenso
Intense Aerated Jet



Getto vigoroso effetto pioggia
Vigorous rain effect jet



Getto Vigoroso ed Ampio
Vigorous and Wide Jet



Getto spray ampia copertura e getto intenso esterno a risparmio idrico
Wide coverage spray jet and intense water saving external jet



Getto soft aerato mischiato ad un getto vigoroso a risparmio idrico
Soft aerated jet mixed with a vigorous water-saving jet



Pioggia soft a risparmio idrico
Soft rain water saving



Getto Esterno
External Jet



Con Getti Anticalcare
With Antilime Jets

COLONNE DOCCIA - SHOWER COLUMNS



Colonna Doccia Girevole
Swivable shower column



Colonna Doccia Telescopica
Telescopic shower column

REMER
RUBINETTERIE

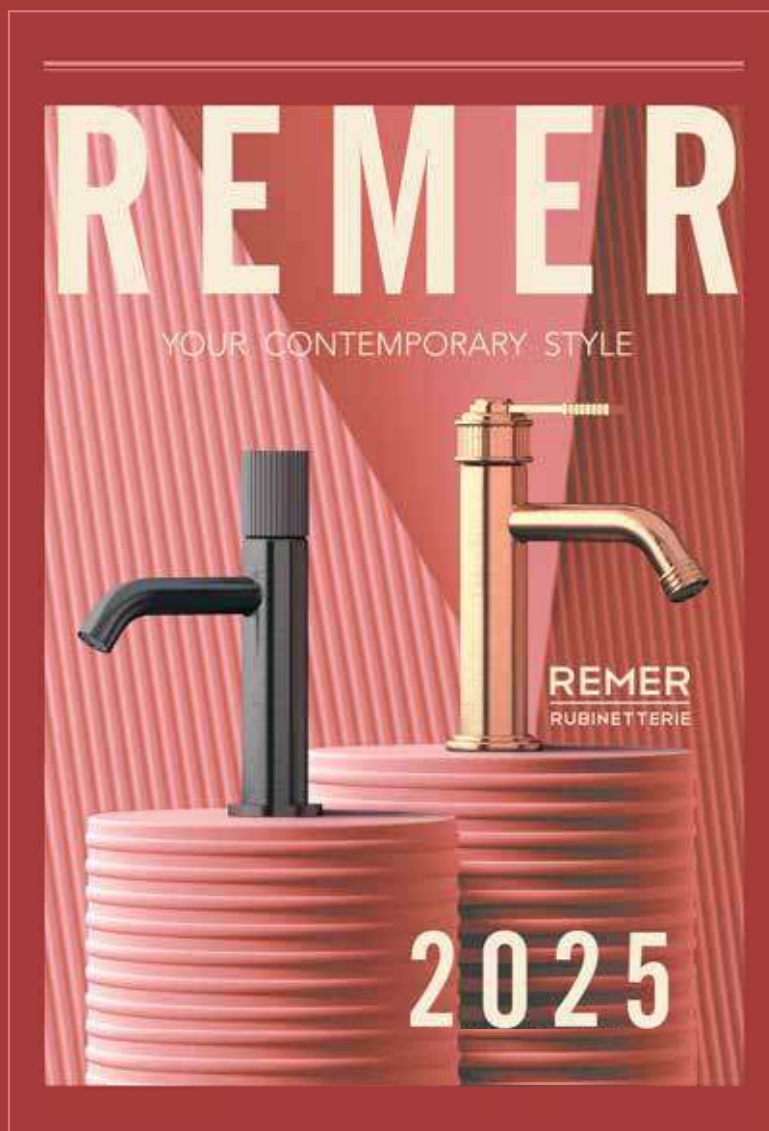

REMER RUBINETTERIE S.P.A.

Via Leonardo da Vinci, 83
20062 Cassano d'Adda
(MI) Italy
Tel. +39 0363 364 330

info@remer.eu
www.remer.eu

UFFICIO COMMERCIALE ITALIA:

Tel. 0363 364 333
Fax 0363 63 575

EXPORT COMMERCIAL DEPARTMENT:

Tel. +39 0363 364 364
Fax +39 0363 364 300