

REMER



ATELIER
COLLECTION

ATELIER

IL GRANDE PASSATO DISEGNA IL PRESENTE
THE GREAT PAST DRAWS THE PRESENT



Nella collezione di miscelatori monocomando ATELIER, i dettagli decorativi dallo stile classico impreziosiscono le superfici di leva, basetta e aeratore, creando un equilibrio di assoluta eleganza con le forme più moderne e minimali del corpo. La collezione si sviluppa su una cartuccia dal diametro di 25mm, 35mm per le figure a incasso.

In the ATELIER single-lever mixer collection, classically styled decorative details adorn the surfaces of the lever, base and aerator, creating a balance of absolute elegance with the more modern and minimalist shapes of the body. The collection is developed on a 25mm diameter cartridge, 35mm for the built-in items.





AL08NO



ATELIER

AL10ACCNO



AL53D2PWBRP



AL12ADO

//////////////////////////////////// OPZIONI DI FINITURA - FINISHING OPTIONS //////////////////////////////////////

CR		FIN 1		FIN 2	
	cromo chrome		nero opaco matt black		cromo nero spazzolato brushed black chrome
	CR		bianco opaco matt white		oro spazzolato brushed gold
			visual inox visual steel		oro lucido shiny gold
			oil bronze oil bronze		rame spazzolato brushed copper
			NO		CFP
			BO		BG
			XV		DO
			BR		RP

MISCELATORI LAVABO - WASHBASIN MIXERS



AL10
Miscelatore monocomando per lavabo, con scarico.
Single-lever basin mixer, with pop-up waste.

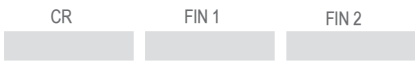

AL10ACC
Miscelatore monocomando per lavabo, modello "A" altezza media, scarico click-clack con troppo-pieno incluso.
Single-lever basin mixer, model "A" medium height, click-clack waste with overflow included.



AL10LXL
Miscelatore monocomando alto per lavabo, misura XL, scarico click-clack con troppo-pieno incluso.
High single-lever washbasin mixer, XL size, click-clack waste with overflow included..

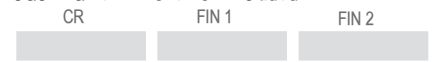

AL12
Miscelatore monocomando per lavabo, senza scarico e senza foro posteriore sul corpo.
Single-lever basin mixer, without waste and without rear body hole.

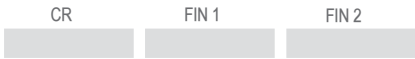

AL12A
Miscelatore monocomando per lavabo, modello "A" altezza media, senza scarico e senza foro sul corpo.
Single-lever basin mixer, model "A" medium height, without pop-up waste and with no rear hole.

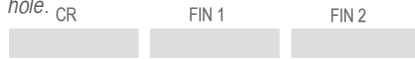

AL11LXL
Miscelatore monocomando alto per lavabo, misura XL, scarico non incluso.
High single-lever washbasin mixer, XL size, waste not included.

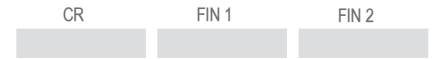

AL57
Miscelatore monocomando per lavabo a due fori. Scarico non incluso.
2-holes single-lever basin mixer. Waste not included.



AL57L
Miscelatore monocomando per lavabo a due fori, con bocca L. Scarico non incluso.
2-holes single-lever basin mixer, with L spout. Waste not included.



AL15
Miscelatore monocomando a incasso per lavabo. Piastra ultra-piatta. Lunghezza bocca 17 cm.
Single-lever built-it basin mixer. Ultra-flat plate. Spout length 17 cm.



AL15L
Miscelatore monocomando a incasso per lavabo. Piastra ultra-piatta. Lunghezza bocca 19 cm.
Single-lever built-it basin mixer. Ultra-flat plate. Spout length 19 cm.





AL15P

Miscelatore monocomando a incasso per lavabo, su due piastre tonde separate. Lunghezza bocca 17 cm.

Built-in single-lever basin mixer with two separate round plates. Spout length 17 cm.

CR FIN 1 FIN 2

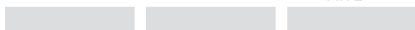

AL15PL

Miscelatore monocomando a incasso per lavabo, su due piastre tonde separate. Lunghezza bocca 19 cm.

Built-in single-lever basin mixer with two separate round plates. Spout length 19 cm.

CR FIN 1 FIN 2

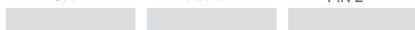

AL18

Miscelatore monocomando da pavimento per lavabo, scarico click-clack con troppo-pieno incluso, articolo completo.

Floor mounting single-lever basin mixer, click-clack waste with overflow included, complete product.

CR FIN 1 FIN 2

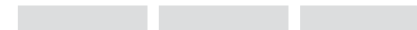

Q08FIS2

Solo parte interna.
Built-in components only.



CR

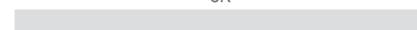

AL18E

Solo parti esterne.
Exposed components only.

CR FIN 1 FIN 2



LAVABO A MURO CON BOX INCASSO - WALL WASHBASIN MIXER WITH BUILT-IN BOX



SOLO PARTE ESTERNA - EXPOSED COMPONENTS ONLY:

AL15WB

Parti esterne per miscelatore monocomando a incasso per lavabo da abbinare al box incasso (non incluso). Piastra ultra-piatta. Lunghezza bocca 17 cm.
Exposed components for single-lever built-in basin mixer, with ultra-flat wall plate. To match with the built-in box (not included). Spout length 17 cm.

CR FIN 1 FIN 2

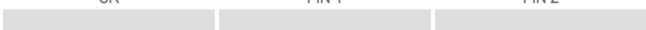

AL15LWB

Idem sopra, con lunghezza bocca 19 cm.
Same as above, with spout length 19 cm.

CR FIN 1 FIN 2

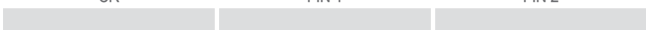

SOLO PARTE ESTERNA - EXPOSED COMPONENTS ONLY:

AL15PWB

Parti esterne per miscelatore monocomando a incasso per lavabo da abbinare al box incasso (non incluso). Su due piastre tonde separate. Lunghezza bocca 17 cm.

Exposed components for single-lever built-in basin mixer, with two separate round plates. To match with the built-in box (not included). Spout length 17 cm.

CR FIN 1 FIN 2

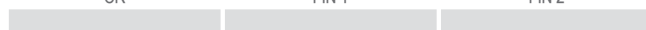

AL15PLWB

Idem sopra, con lunghezza bocca 19 cm.
Same as above, with spout length 19 cm.

CR FIN 1 FIN 2



SOLO PARTE INTERNA - BUILT-IN COMPONENTS ONLY:

WBOX15

SOLO PARTE INTERNA - BUILT-IN COMPONENTS ONLY:

WBOX15

MISCELATORI PER BIDET - BIDET MIXERS



AL20
Miscelatore monocomando per bidet, con scarico.
Single-lever bidet mixer, with pop-up waste.



AL22
Miscelatore monocomando per bidet, senza scarico e senza foro posteriore sul corpo.
Single-lever bidet mixer, without waste and without rear body hole.



AL65Z
Set shut-off comprensivo di: miscelatore a incasso con supporto doccia/presa acqua, doccetta a pulsante(332OZ), tutto in ottone. Flessibile doccia cm 120.
Shut-off set including: built-in mixer with shower holder/water punch on flange, shut-off hand shower (332OZ), all in brass. Flexible hose cm 120.

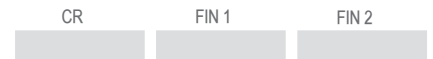

MISCELATORI ESTERNI PER VASCA - EXPOSED MIXERS FOR BATH

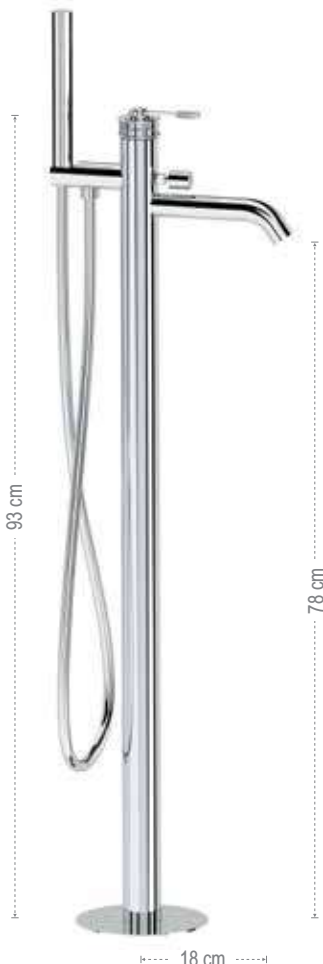

AL08
Miscelatore bordo vasca da pavimento, con deviatore e kit doccetta in ottone. Prodotto completo.
Floor mounting single-lever bath mixer, with diverter and brass hand shower kit. Complete product.



Q08FIS2
Solo parte interna.
Built-in components only.



AL08E
Solo parti esterne.
Exposed components only.



AL02
Miscelatore monocomando per vasca, con kit doccetta in ottone ad 1 funzione. Flessibile 150cm.
Wall mounted single-lever bath mixer with 1-function brass hand shower kit. 150cm flexible hose.

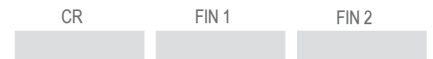

AL05
Miscelatore monocomando per vasca, senza kit doccia.
Wall mounted single-lever bath mixer, without shower kit.



MISCELATORI A INCASSO PER VASCA - BUILT-IN MIXERS FOR BATH



SOLO PARTE ESTERNA - EXPOSED COMPONENTS ONLY:

AL53D2PWB

Set a incasso a 2 vie per vasca su piastre tonde separate.
2-way built-in set for bathtub on separate round plates.

CR

FIN 1

FIN 2



SOLO PARTE ESTERNA - EXPOSED COMPONENTS ONLY:

AL53D2WB

Set a incasso a 2 vie per vasca su piastra unica rettangolare.
2-way built-in set for bathtub on a single rectangular plate.

CR

FIN 1

FIN 2

SOLO PARTE INTERNA - BUILT-IN COMPONENTS ONLY:

WBOX97D2

pag 304

SOLO PARTE INTERNA - BUILT-IN COMPONENTS ONLY:

WBOX97D2

pag 304



SOLO PARTE ESTERNA - EXPOSED COMPONENTS ONLY:

AL54D2PWB

Set miscelatore a incasso a 2 vie per vasca/doccia su 3 piastre tonde. Da completare con la seconda uscita acqua.
2-way built-in mixer set for bathtub / shower on 3 round plates. To be completed with the second water outlet.

CR

FIN 1

FIN 2

SOLO PARTE INTERNA - BUILT-IN COMPONENTS ONLY:

WBOX97D2

pag 304



SOLO PARTE ESTERNA - EXPOSED COMPONENTS ONLY:

AL54D2WB

Set miscelatore a incasso a 2 vie per vasca/doccia su piastra unica rettangolare. Da completare con la seconda uscita.
2-way built-in mixer set for bathtub / shower on single rectangular plate. To be completed with the second water outlet.

CR

FIN 1

FIN 2

SOLO PARTE INTERNA - BUILT-IN COMPONENTS ONLY:

WBOX97D2

pag 304



SOLO PARTE ESTERNA - EXPOSED COMPONENTS ONLY:

AL54D3PWB

Set miscelatore a incasso a 3 vie per vasca/doccia su 3 piastre tonde. Da completare con la seconda e la terza uscita acqua.
3-way built-in mixer set for bathtub / shower on 3 separate round plates. To be completed with the second and the third water outlet.

CR

FIN 1

FIN 2

SOLO PARTE INTERNA - BUILT-IN COMPONENTS ONLY:

WBOX97D3

pag 308



SOLO PARTE ESTERNA - EXPOSED COMPONENTS ONLY:

AL54D3WB

Set miscelatore a incasso a 3 vie per vasca/doccia su piastra unica rettangolare. Da completare con la seconda e la terza uscita acqua.
3-way built-in mixer set for bathtub / shower on single rectangular plate. To be completed with the second and the third water outlet.

CR

FIN 1

FIN 2

SOLO PARTE INTERNA - BUILT-IN COMPONENTS ONLY:

WBOX97D3

pag 308

Set doccia acquistabile separatamente a pagina 427 - Shower set can be purchased separately on page 427

MISCELATORI A INCASSO PER DOCCIA - BUILT-IN MIXERS FOR SHOWER



AL30L

Miscelatore a incasso per doccia, su piastra tonda ultra-piatta.
Built-in shower mixer, ultra-flat round wall plate.

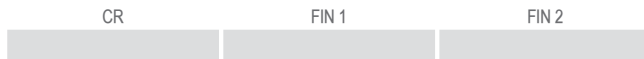

AL30Q

Miscelatore a incasso per doccia, su piastra quadrata ultra-piatta.
Built-in shower mixer, ultra-flat square wall plate.

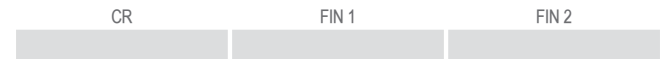

SOLO PARTE ESTERNA - EXPOSED COMPONENTS ONLY:

AL92ZPWB

Miscelatore a incasso per vasca/doccia con deviatore a 2 vie di tipo meccanico, su due piastre tonde.
Built-in bath/shower mixer with 2-way mechanical diverter, on two round plates.

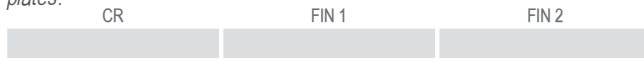

SOLO PARTE ESTERNA - EXPOSED COMPONENTS ONLY:

AL92ZWB

Miscelatore a incasso per vasca/doccia con deviatore a 2 vie di tipo meccanico, su piastra rettangolare.
Built-in bath/shower mixer with 2-way mechanical diverter, on rectangular plate.

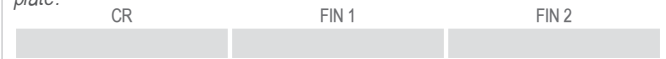

SOLO PARTE INTERNA - BUILT-IN COMPONENTS ONLY:

WBOX92Z

pag 300

SOLO PARTE INTERNA - BUILT-IN COMPONENTS ONLY:

WBOX92Z

pag 300

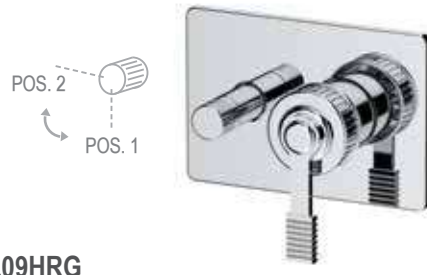
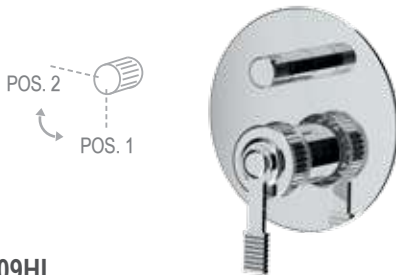

AL09HL

Miscelatore a incasso per vasca/doccia con deviatore a 2 vie a vitone ceramico. Per selezionare l'uscita desiderata, la manopola del deviatore deve essere ruotata da una posizione all'altra.
Built-in bath/shower mixer with 2-way diverter with ceramic head valve. To select the desired output, the diverter knob must be turned from one position to the other.



AL09HRG

Miscelatore a incasso per vasca/doccia con deviatore a 2 vie con vitone ceramico, su piastra rettangolare, montaggio orizzontale. Per selezionare l'uscita desiderata, la manopola del deviatore deve essere ruotata da una posizione all'altra.
Built-in bath/shower mixer with 2-way diverter with ceramic head valve, on rectangular plate, horizontal mounting. To select the desired output, the diverter knob must be turned from one position to the other.



N09HB

Solo parte interna.
Built-in components only.



AL09LE

Solo parte esterna.
Exposed components only.



N09HRB

Solo parte interna.
Built-in components only.



AL09GE

Solo parte esterna.
Exposed components only.





2 VIE
WAYS



SOLO PARTE ESTERNA - EXPOSED COMPONENTS ONLY:

AL97D2PWB

Set miscelatore a incasso a 2 vie per vasca/doccia su 3 piastre tonde.
Da completare con la seconda uscita.
2-way built-in shower mixer set on 3 round plates. To be completed with the second water outlet.

CR FIN 1 FIN 2

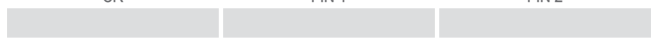

SOLO PARTE INTERNA - BUILT-IN COMPONENTS ONLY:

WBOX97D2

> pag 304



SOLO PARTE ESTERNA - EXPOSED COMPONENTS ONLY:

AL97D2WB

Set miscelatore a incasso a 2 vie per vasca/doccia su piastra rettangolare.
Da completare con la seconda uscita.
2-way built-in shower mixer set on rectangular plate. To be completed with the second water outlet.

CR FIN 1 FIN 2



SOLO PARTE INTERNA - BUILT-IN COMPONENTS ONLY:

WBOX97D2

> pag 304



3 VIE
WAYS



SOLO PARTE ESTERNA - EXPOSED COMPONENTS ONLY:

AL93ZPWB

Miscelatore a incasso per vasca/doccia con deviatore a 3 vie di tipo meccanico, su due piastre tonde.
Built-in bath/shower mixer with 3-way mechanical diverter, on two round plates.

CR FIN 1 FIN 2



SOLO PARTE INTERNA - BUILT-IN COMPONENTS ONLY:

WBOX93Z

> pag 302



SOLO PARTE ESTERNA - EXPOSED COMPONENTS ONLY:

AL93ZWB

Miscelatore a incasso per vasca/doccia con deviatore a 3 vie di tipo meccanico, su piastra rettangolare.
Built-in bath/shower mixer with 3-way mechanical diverter, on rectangular plate.

CR FIN 1 FIN 2



SOLO PARTE INTERNA - BUILT-IN COMPONENTS ONLY:

WBOX93Z

> pag 302



3 VIE
WAYS



SOLO PARTE ESTERNA - EXPOSED COMPONENTS ONLY:

AL97D3PWB

Set miscelatore a incasso a 3 vie per vasca/doccia su 3 piastre tonde. Da completare con la seconda e la terza uscita acqua.
3-way built-in bath/shower mixer set on 3 round plates. To be completed with the second and the third water outlet.

CR FIN 1 FIN 2

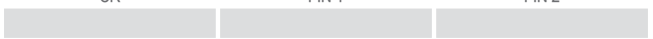

SOLO PARTE INTERNA - BUILT-IN COMPONENTS ONLY:

WBOX97D3

> pag 308



SOLO PARTE ESTERNA - EXPOSED COMPONENTS ONLY:

AL97D3WB

Set miscelatore a incasso a 3 vie per vasca/doccia su piastra rettangolare. Da completare con la seconda e la terza uscita acqua.
3-way built-in shower mixer set on rectangular plate. To be completed with the second and the third water outlet.

CR FIN 1 FIN 2



SOLO PARTE INTERNA - BUILT-IN COMPONENTS ONLY:

WBOX97D3

> pag 308

LEGENDA ICONE - *ICONS LEGEND*



Acciaio INOX
Stainless Steel



Perfect Tune: Prodotto diponibile in più varianti.
Perfect Tune: Product available in different variants.

RUBINETTERIA - FAUCETS



Con scarico
With pop-up waste



Con scarico in plastica
With plastic waste



Con Click-Clack
With Click-Clak



Con Click-Clack con Troppo Pieno
With Click-Clak with Overflow



Senza Scarico
Without Waste



Eco
Eco



Cartuccia Energy Saving
Energy Saving Cartridge



Limitatore di Temperatura
Antiscalding



Risparmio Idrico Dinamico
Water Saving Dynamic



Risparmio Idrico
Water Saving



Risparmio Energetico
Energy Saving



Risparmio Idrico e Energetico
Water and Energy Saving

CUCINA - KITCHEN



Bocca Girevole
Swivel Spout



Corpo girevole
Swivel body



Doccetta Orientabile
Adjustable handshower



Doccetta Estraibile
Pull-Out Handshower



Bocca Abbattibile
Folding Spout



Doccetta a due funzioni
Two functions hand shower.



Acqua Frizzante
Sparkling Water



Acqua Potabile
Drinking Water

TECNOLOGIA - TECHNOLOGY



Touch-Me
Touch-Me



Tempor Touch
Tempor Touch



Con Luce Led
Whit Led Light



Con Batterie Alcaline Include
With Alkaline Batteries included



Alimentazione Elettrica
Power Supply



Azionamento a Sensore
Sensor Control



Con Temporizzazione per Lavatrice/Lavastoviglie
With Timing for washing/machine and Dish/Washer



Con filtro incluso
With filter included



Con Batterie al Litio Include
With Lithium Batteries included



Termostatico
Thermostatic

SOFFIONI - SHOWER HEADS



Getto effetto pioggia ad ampia copertura
Wide coverage rain effect



Getto effetto pioggia a risparmio idrico
Water-saving rain effect jet



Con Multigetto
With Multi Jet



Con Getto a Cascata
With Waterfall Jet



Getto Nebulizzato
Nebulized Jet



Cromoterapia
Colortherapy



Autopulente
Self-Cleaning



Con Getti Anticalcare
With Antilimestone Jets

DOCCHETTE - HANDSHOWERS



Posizione d'interruzione getto
Stop flow position



Getto intenso esterno con getto effetto pioggia interno
Intense external jet with internal rain effect jet



Getto intenso a risparmio idrico
Intense water-saving jet



Massaggio vigoroso ampia copertura effetto pioggia
Vigorous massage wide coverage rain jet



Getto vigoroso concentrato e getto esterno
Concentrated vigorous jet and external jet



Getto vigoroso concentrato
Vigorous concentrated jet



Getto Aerato Intenso
Intense Aerated Jet



Getto vigoroso effetto pioggia
Vigorous rain effect jet



Getto Vigoroso ed Ampio
Vigorous and Wide Jet



Getto spray ampia copertura e getto intenso esterno a risparmio idrico
Wide coverage spray jet and intense water saving external jet



Getto soft aerato mischiato ad un getto vigoroso a risparmio idrico
Soft aerated jet mixed with a vigorous water-saving jet



Pioggia soft a risparmio idrico
Soft rain water saving



Getto Esterno
External Jet



Con Getti Anticalcare
With Antilimestone Jets

KIT DOCCIA - SHOWER KIT



2 Vie
2 Ways



3 Vie
3 Ways



4 Vie
4 Ways



5 Vie
5 Ways



Flessibile Lungo 120 cm
Flexible Length 120 cm



Flessibile Lungo 150 cm
Flexible Length 150 cm



Flessibile Lungo 200 cm
Flexible Length 200 cm

COLONNE DOCCIA - SHOWER COLUMNS



Colonna Doccia Girevole
Swivable shower column



Colonna Doccia Telescopica
Telescopic shower column

REMER
RUBINETTERIE

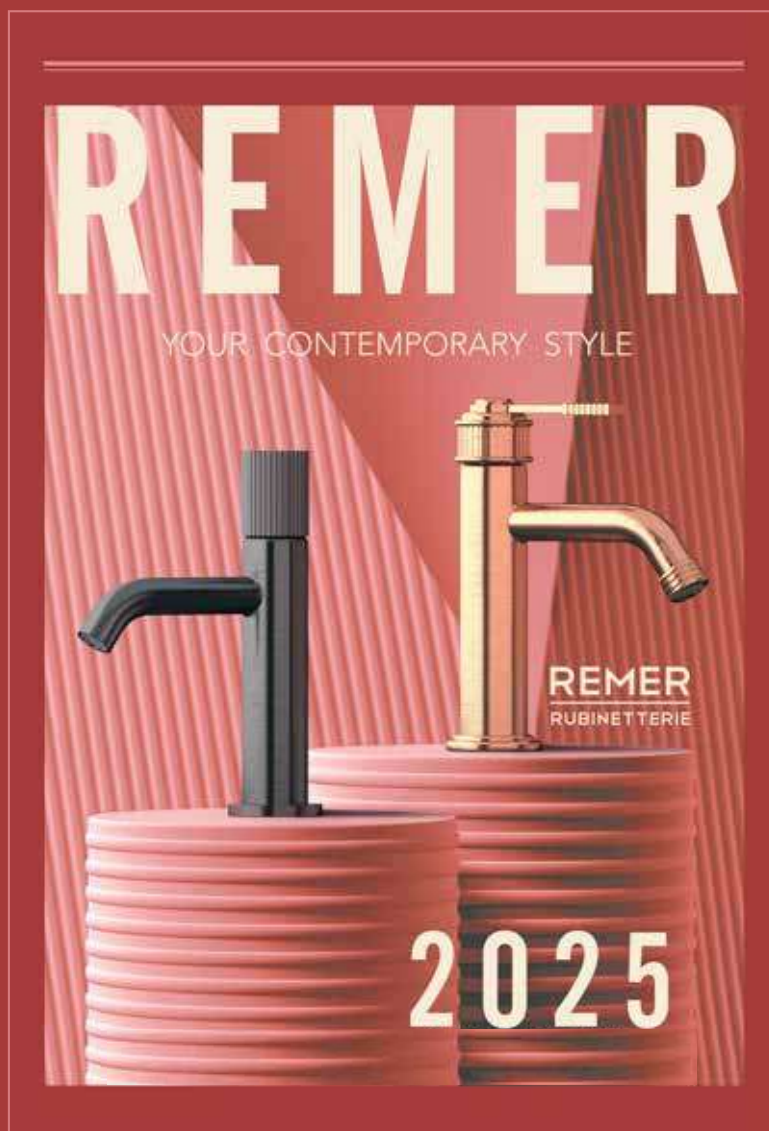

REMER RUBINETTERIE S.P.A.

Via Leonardo da Vinci, 83
20062 Cassano d'Adda
(MI) Italy
Tel. +39 0363 364 330

info@remer.eu
www.remer.eu

UFFICIO COMMERCIALE ITALIA:

Tel. 0363 364 333
Fax 0363 63 575

EXPORT COMMERCIAL DEPARTMENT:

Tel. +39 0363 364 364
Fax +39 0363 364 300